



*Superior Design & Craftsmanship*

**Wine Rack  
Assembly Instructions**

**Modular Wine Cabinets**



## **Parts List:**

Before starting, carefully review the parts and quantities against the parts list to make sure you have everything you need. Then read through the instructions, taking time to familiarize yourself with the pieces and the steps.

## **Tools Required**

#2 Phillips head screwdriver  
Wood glue (Recommended)

## **Modular Parts List:**

### **Cabinet Parts:**

- (1) Part A - Left Side Panel
- (1) Part B - Right Side Panel
- (1) Part C - Top Panel
- (1) Part D - Bottom Panel
- (1) Part E - Back Panel
- (1) Part F - Toe Kick Board

### **Hardware:**

- (7) Part G - Modesty Blocks
- (21) Part H - #8 x 1" Modesty Block Screws
- (8) Part K - #8 x 1 3/4" Square Head Screws
- (16) Part M - Shelf Pins
- (4) Part N - #8 x 1 1/4" Tabletop Screws

### **Optional Tabletop List:**

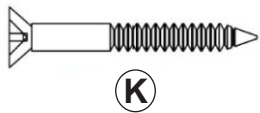
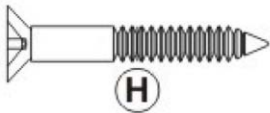
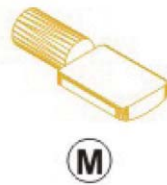
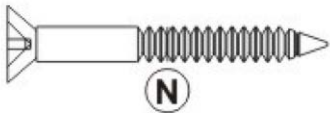
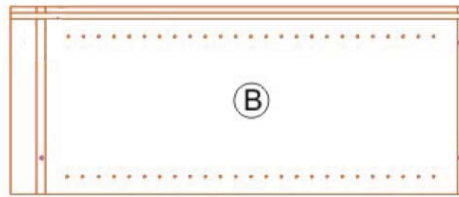
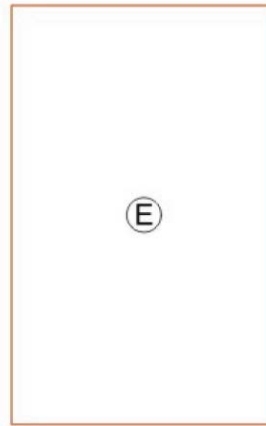
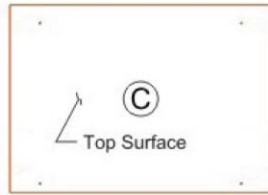
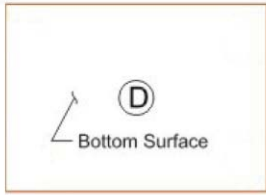
- Part P - Slim Table Top
  - Deep Table Top
  - Slim Double-Wide Table Top
  - Deep Double-Wide Table Top

### **Optional Inserts List:**

- Part R - Diamond Cube Insert (Optional)
- Part S - Slim Shelf (Optional)
- Part T - Deep Shelf (Optional)
- Part U - Stemware Shelf (Optional)
- Part V - Slotted Display Shelf (Optional)
- Part W - Cubbie Insert (Optional)

### **Optional Accessories:**

- Full-Height Glass Door (Optional)
- Full-Height Wood Door (Optional)
- Drawer-Height Glass Door (Optional)
- Drawer-Height Wood Door (Optional)
- Drawer (Optional)
  - (4) Part Q - #8 x 7/16" Pan Head Drawer
  - Assembly Screws
- Wine Bottle Drawer Divider (Optional)
- Drawer Handle Pulls (Optional)
- Top Molding Cleat (Optional)



<b>Item</b>	<b>Description</b>
A	Left Side Panel
B	Right Side Panel
C	Top Panel
D	Bottom Panel
E	Back Panel
F	Toe Kick
G	Modesty Block
H	#8 x 1" Modesty
K	#8 x 1-3/4" Square Head Screw
L	Shelf Pin
M	#8 x 1-1/4" Table Top Screw

## Parts List



## **Tips: For Modular**

Do not use a power drill when tightening your screws. If you do you could pierce the outside of the wood.

Place a blanket down before assembling your wine storage bin or case. You want a clean and scratch free surface during assembly.

It is recommended to use glue at joints whenever possible to make the joint stronger.

Pre-drill all screw holes with a 9/64" drill bit. This makes it less likely for your wood to split. (The easiest way to do this is to follow the pre-drilled holes provided on certain pieces as your guide.)

It is recommended that neither the Classic nor the Estate Series be pulled to the full depth of the cabinet. You either want to pull the racking out so that the spacer bar is flush with the cabinet (where you would be able to have a continuous base and crown molding) or push the racking against the wall (where you would have to move your crown and base molding in and out along your assemblies).

With bins and cases, pull out the racking so that the face frame is flush with the cabinet. This makes it easier to attach the crown molding.

If you are adding a conversion box on top of a 10 Column Soffit Arch that sits on two modular cabinets, you will need to attach two cleats to the bottom of that conversion box to get the correct height. You will want to attach one cleat flush to the front of the box and attach the other cleat flush with the back of the box.

If you are adding crown molding to your cabinet when you have Classic racking around it, you will need to add a cleat flush to the top to attach the molding to.

If you are adding crown molding to your cabinet when you have Estate racking around it, you will need to attach the two cleats to the bottom outside of your conversion box (one flush to the front and one flush to the back).

If you have a conversion box on top of a modular assembly on an exposed end of your cellar and it does not have racking on the other side, you will need to bring the conversion box flush to the front of the cabinet (not the cabinet door) and fill the gap behind it with filler strip.

If you have a conversion box on top of a modular assembly on an exposed end of your cellar and it does have racking on the other side, you will need to bring the conversion box flush with the spacer bars and fill the gap behind it with filler strip.

## **How to Care for Your Stained & Lacquered Wine Racks**

Your Vigilant wine racks are built using the highest quality wood and finish available. When properly cared for, your wine racks will last longer than your finest bottles of wine. Here are a few tips on maintaining the quality and consistency of your racking.

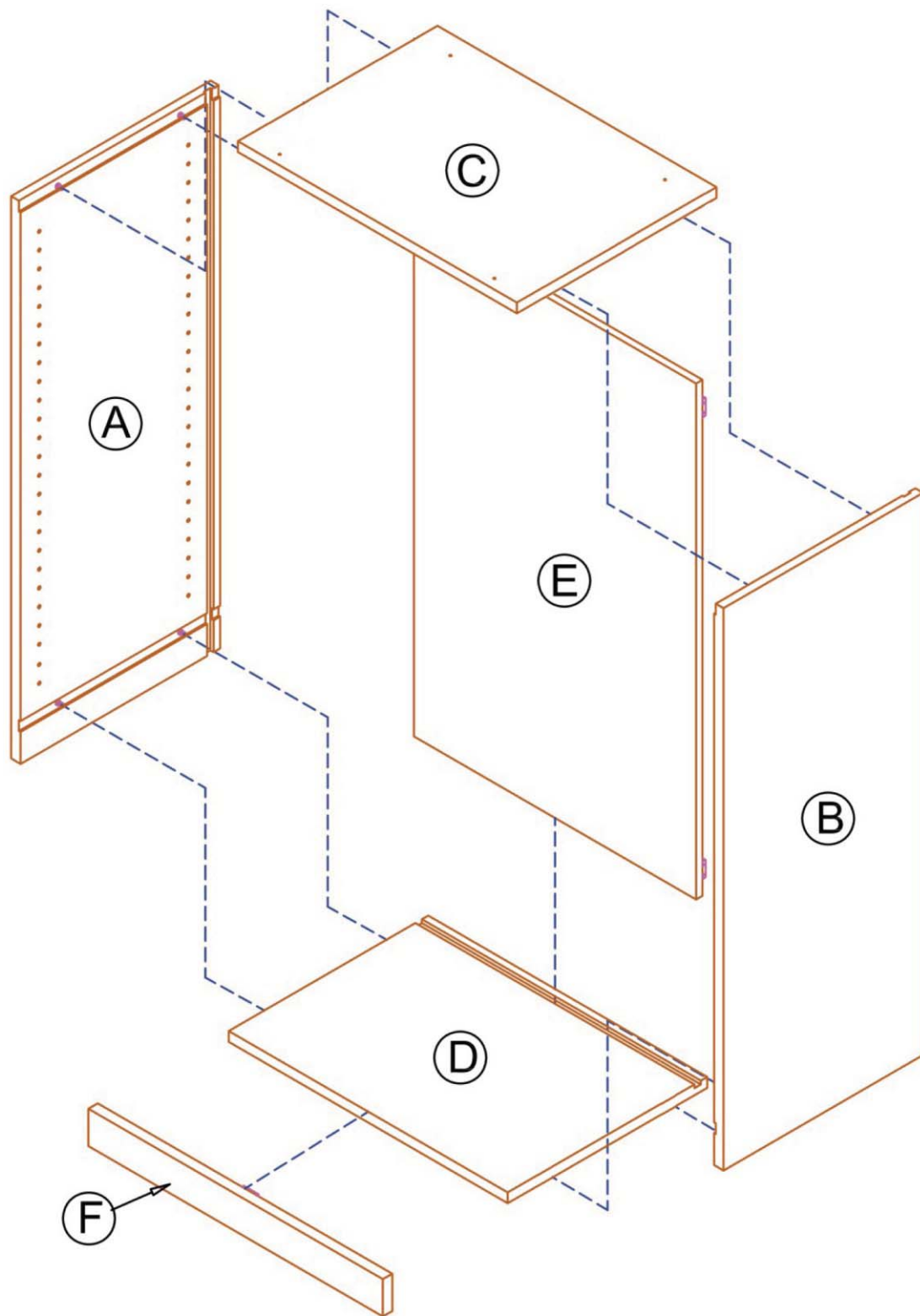
**Remove Dust:** Dust build up from small airborne particles may scratch the surface if not removed correctly. Simply wipe the surface with a cloth dampened with a cleaning polish or mild detergent.

**Clean:** Fingerprints, cooking fumes, smoking residue, etc., accumulate on any surface. None of these contaminants will harm our Satin lacquer finish, but they should be periodically removed to restore the finish to its original luster. Just wipe the surface with a cloth dampened with a non-wax containing polish or mild detergent solution. Avoid the use of ammonia based products or silicone oil, as they may cause damage if used over a long period of time.

Our Satin lacquer finish is durable and resistant to most household spills. However, spills should be wiped up promptly to avoid potential problems.

Excessive prolonged exposure to direct sunlight, high temperatures and high humidity can cause damage to both the finish and the wood itself. These should be avoided.

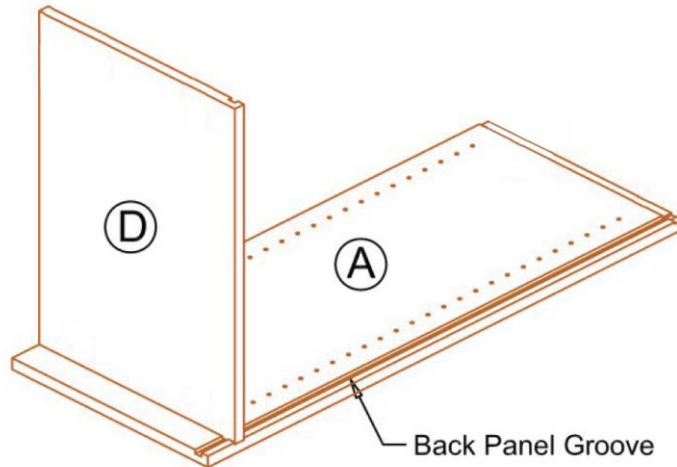
Following these simple steps will keep your finished wine racks looking like new for many years.



**Exploded View**

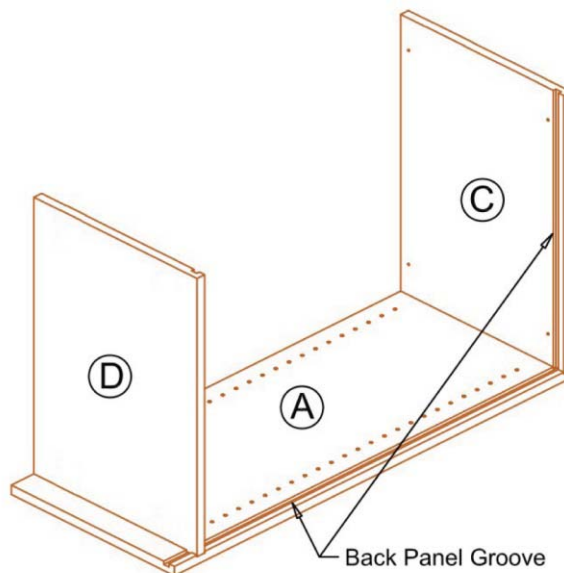
1. Locate all cabinet parts, labeled A-F as shown on the **(Parts List)** and lay them out on a flat surface w/ fastener & shelf pin surfaces facing up. All cabinet parts are labeled on their back edge.

2. Locate the panels labeled A (left side panel) & D (bottom panel). Secure panel A to panel D using the pre-drilled holes and #8 1-3/4" screws provided **(Figure 1)**.



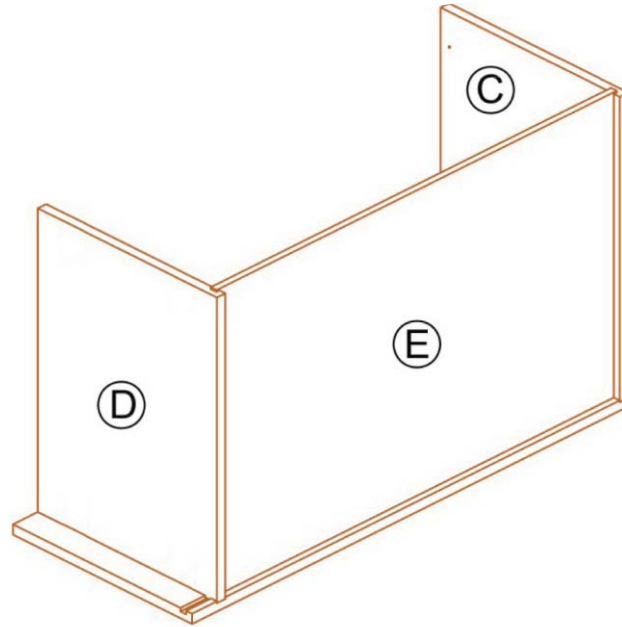
**Figure 1**

3. Locate the panel labeled C (top panel) and attach to panel A using the pre-drilled holes and screws provided **(Figure 2)**. Make sure the back panel grooves are aligned as shown in **Figure 2**.



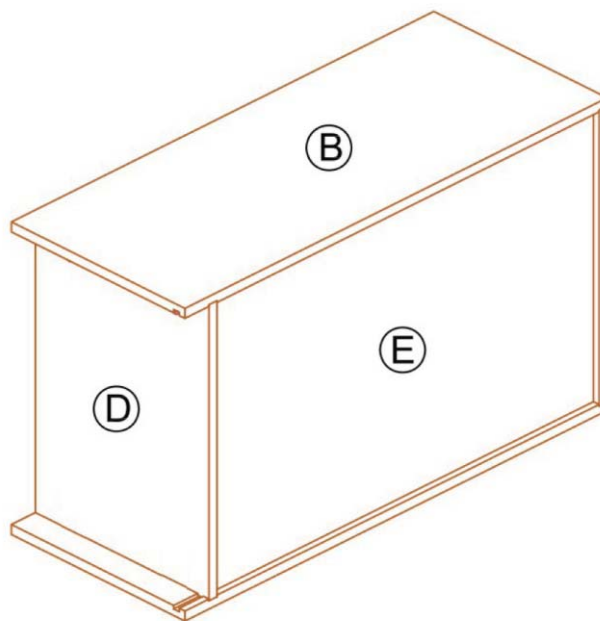
**Figure 2**

4. Locate the back panel labeled E and slide it into the panel grooves as show in **Figure 3**.



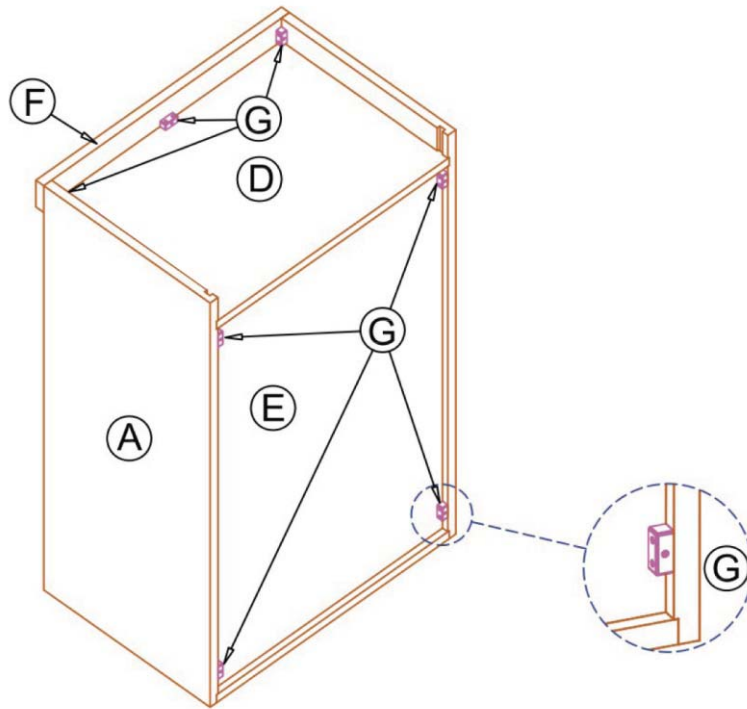
**Figure 3**

5. Place the side panel labeled B, with the slots and panel grooves facing the cabinet interior, onto the cabinet assembly (**Figure 4**). Secure the panel using the pre-drilled holes and screws provided.



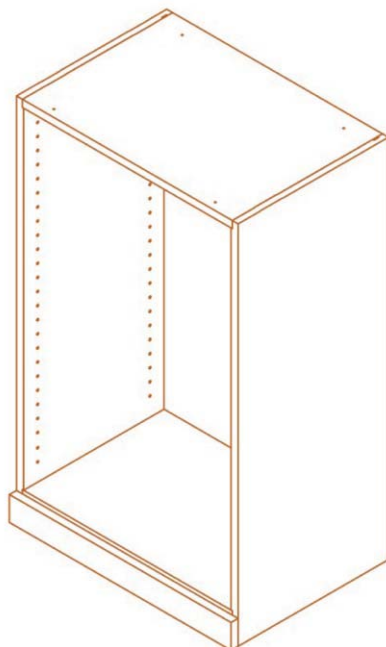
**Figure 4**

6. Turn the cabinet upside down so it rests on the top panel. Using the 3 modesty blocks (item G on the Parts List) and six #8 1" modesty block screws, fasten the blocks using the pre-drilled screw holes in panels A, B and D (**Figure 5**). Using 3 modesty block screws, attach the kick board (item F on the Parts List) to the cabinet assembly aligning the pre-drilled holes in the toe kick with the modesty blocks.

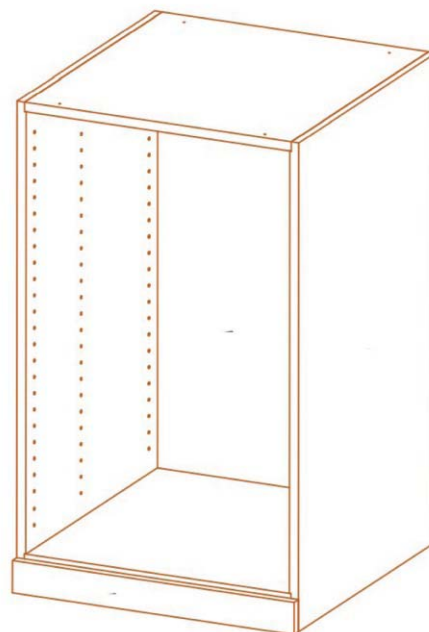


**Figure 5**

7. Turn the cabinet on face and place remaining modesty blocks in the pre-drilled locations on the back of the cabinet assembly as show in **Figure 5**. Using 8 modesty block screws, screw the modesty blocks in the back panel E (**Figure 5**).



**Slim Cabinet Assembled**



**Deep Cabinet Assembled**



## **Optional Accessories Assembly**

### **Optional Tabletop Assembly:**

Parts List: (1) Tabletop  
(4) Tabletop Screws

Set your tabletop onto your assembled cabinets, aligning it flush to the sides and back of the cabine(s). It should overhang the front by 1½". Firmly hold or clamp the top in place and drive the (4) provided tabletop screws [N], through the pre-drilled holes in the cabinet top(s) as shown in the **(Exploded View)**.

### **Optional Top Molding Cleat Assembly:**

Parts List: (1) Top Molding Cleat  
(3) Top Molding Cleat Screws

#### **Applied as a top molding nailer:**

If you are incorporating your modular cabinets with Vigilant wine rack kits, the top cleat is needed to bring the top modular cabinet up to 77 ½" or 92 ½" racking height and also provides a nailing surface for the standard kit top molding application.

In this case the cleat should be screwed to the top of the cabinet with the square edge flush to the front edge of the cabinet.

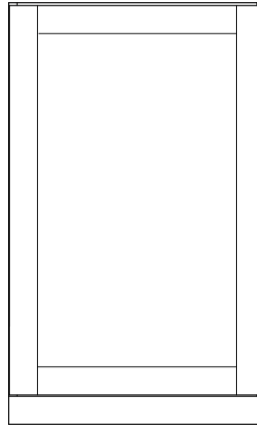
#### **Applied as a top finish trim:**

If you desire a top trim detail for your stand-alone modular cabinets, simply screw the top molding cleat to the top of the cabinet with the bull nose detail hanging 3/4" off the front edge of the cabinet.

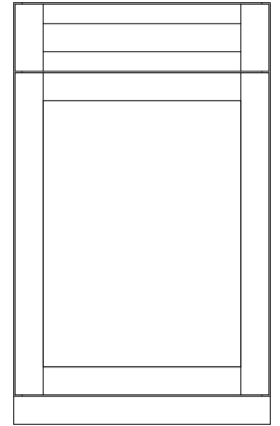
## Optional Glass Door Installation:

### Parts List:

- (1) Door
- (2) Hinges
- (2) Hinge Plates



**Full-Height**



**Drawer-Height**

1. The versatility of the Vigilant hardware allows you to mount your door to either side of the cabinet. Therefore, you must first determine which side of the cabinet the hinges will be fastened to.
2. If you are installing a drawer and drawer-height door, install the drawer first (**See Drawer Installation on page 11**).
3. Take the first hinge plate with the arrows pointing toward the front of the cabinet and insert the two black pins in the plate into the pre-drilled holes on the side of the cabinet (**Image 1**). For a full-height door, the pins go into the 2nd and 3rd holes down from the TOP of the cabinet. For a drawer-height door, the pins go into the 7th and 8th holes down from the TOP of the cabinet. Snap the levers firmly into place.



**Image 1**

4. Take the second hinge plate and repeat step 2 by inserting the black hinge plate pins into the 2nd and 3rd holes from the BOTTOM of the cabinet, making sure to press the plate firmly against the cabinet side and snapping the levers closed.
5. Lay the door on a flat, scratch-free surface with the hinge holes facing up. Take the first hinge and with the rectangular cover plate open press the round part of the hinge firmly into the holes in the door and snap the rectangular plate closed.
6. Repeat step 5 for the second hinge.

7. Standing the door upright, open the hinges and line them up with the hinge plates on the cabinet.
8. Align the barrel on the inside of the hinge arm with the two teeth on the front of the hinge plate and press the hinge onto the plate by first pushing back then down onto the plate until it snaps into place (**Image 2**).



**Image 2**

9. Repeat for the second hinge. You may need to rotate the adjustment screws on the hinge plates in order to get proper vertical alignment between the two hinges.
10. Close the door and check it for proper alignment. If the door is not closing properly or does not align exactly with the cabinet front then some simple adjustments will be required.

**Moving the door up or down:**

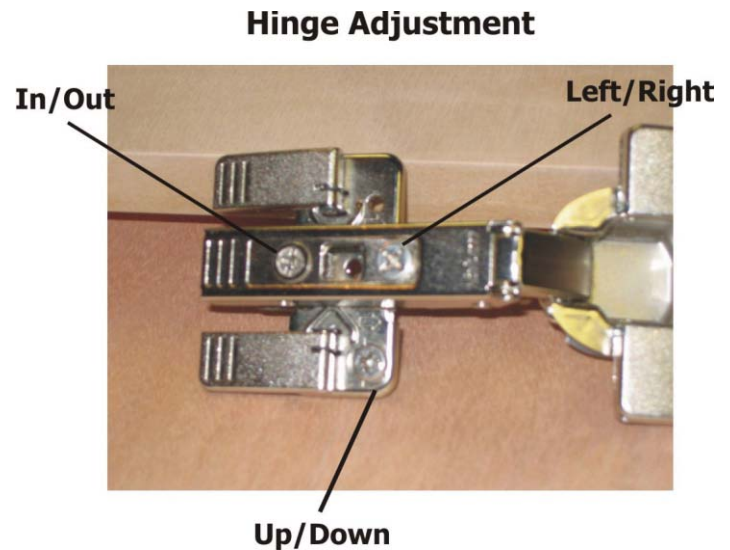
Turn the adjustment screws on the hinge plate to bring the door up or down. Both screws must be adjusted.

**Moving the door left or right:**

Turn the adjustment screw on the front of the hinge arm to move the door left or right. Both hinges may require this adjustment in order to get the door square to the cabinet.

**Moving the door in or out:**

Turn the adjustment screw on the back of the hinge arm to move the door closer to the cabinet or further away. This may be required in order to get the door to land properly on the cabinet front.



**Image 3**

**Door Pull**

Once your door is installed onto the cabinet, decide where to place the door pull (top, middle or bottom). Pre-drill a screw hole with a 3/16" drill bit. Be sure to place a scrap of wood on the back side of the door while pre-drilling to prevent the wood from chipping on the opposite side. Attach the door pull with the screw provided.

## Optional Drawer Installation:

Parts List: (1) Drawer w/ Attached Male & Female Slides  
(4) Drawer Assembly Screws

1. First determine whether the drawer will be located in the top or bottom of the cabinet opening. Locate the pre-drilled drawer slide screw holes on the interior of the side panels A and B.

**Note: if you choose to put a drawer in the lower part of the cabinet, you will require a shelf above it)**

2. Detach the female drawer slides from the male slides attached to the drawer assembly by locating and maneuvering the black locking tabs on the sides of the slide assemblies and pulling the female slide towards the back of the drawer assembly along the track until it slides out. Take one of the female drawer slides and two screws and set the slide against the interior of cabinet side A, aligning the large black tab on the slide with the front of the cabinet (**Image 4**).



**Image 4**

3. Align the holes in the slide with the holes in the cabinet and drive the two screws through the slide and into the holes in the cabinet (**Image 5**).



**Image 5**

4. Repeat steps 2 and 3 for the second slide installation in panel B.

5. Pull the bearing assembly on the female slides towards the front of the cabinet.

6. Aligning the male slide parts on the drawer with the female slides on the cabinet, firmly slide the drawer into the cabinet along the slides.

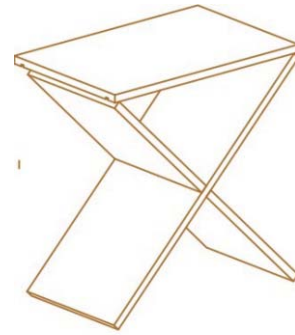
7. Push the drawer all the way in before pulling it out again. The drawer can be adjusted up or down on each side by loosening the front slide screws.

### Drawer Pull

Once your drawer is installed in the cabinet, determine the placement of the drawer pull by locating the center of the drawer front. Pre-drill a screw hole with a 3/16" drill bit. Be sure to place a scrap of wood on the back side of the drawer while pre-drilling to prevent the wood from chipping on the opposite side. Attach the door pull with the screw provided.

## Optional Diamond Cube Insert:

Parts List: (2) Front Angled Panels  
(1) Shelf Unit

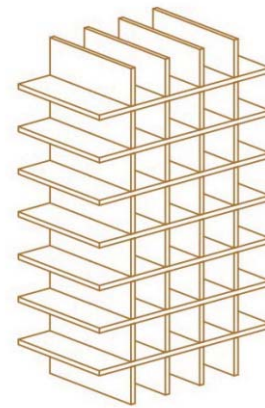


DIAMOND CUBE  
INSERT

1. Stand one of the angled panels on its long edge with the slot facing up.
2. Hold the second panel perpendicular to the first panel with the slot facing down. Align the slots in the panels and interlock the panels by sliding the second panel down onto the first.
3. Place the assembled panels into the cabinet and place the shelf across the top.

## Optional Cubbie Insert:

Parts List: (4) Vertical Panels  
(7) Horizontal Panels



INDIVIDUAL CUBBIE

Note: When installing a cubbie insert into a cabinet with a door attached the door must first be removed or the insert must be assembled standing in the cabinet.

1. Stand the four vertical panels upright and take the upper most horizontal panel and push it into the slots that have been pre-cut in the vertical panels. (Once you have the panel firmly in place it will create a brace that will easily allow you to connect the other panels.)
2. Repeat step 1 for the bottom most horizontal panel.
3. Repeat Step 1 for all remaining horizontal panels.

## Other Optional Inserts:



SLOTTED DISPLAY SHELF



DEEP SHELF



STEMWARE SHELF



DRAWER INSERT



SLIM SHELF

## Soffit Installation for the Marseille package:



Pre-drill four screw holes from inside each top cabinet. To ensure that the screws do not show through the archtop, place the screw holes at a minimum of 1" from the front and back of the cabinet and 2" from the bottom of the archtop. Attach the cabinet to the soffit archtop using 1 1/2" woodscrews (provided) as shown above.

**Note: The screws will break through the bead board paneling if you drill less than 2" from the bottom of the archtop**

**Note: Replacing a bulb in your beadboard soffit is as simple as removing the diffuser trim, removing the bulb, and replacing it with a new glass wedge bulb (SKU-VALDISKBULB)**





*Superior Design & Craftsmanship*

**Questions?**

Please contact our Customer Service Department  
at 888-812-4427

Vigilant Inc.  
85 Industrial Park Drive  
Dover, NH 03820  
(603) 285-0400

[Info@vigilantinc.com](mailto:Info@vigilantinc.com)  
Website: [vigilantinc.com](http://vigilantinc.com)